

## NPN General Purpose Transistor

### FEATURES

- Low reverse current, high reliability
- Surface device type mounting
- Moisture sensitivity level 1
- Matte Tin(Sn) lead finish with Nickel(Ni) underplate
- High temperature soldering guaranteed : 260°C/10s
- RoHS Compliant
- Halogen-free according to IEC 61249-2-21

### APPLICATIONS

- General-purpose switching and amplification

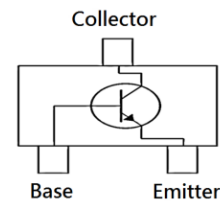
### MECHANICAL DATA

- Case: SOT-323
- Terminal: Matte tin plated, lead free., solderable per MIL-STD-202, Method 208 guaranteed
- Weight: 5.00mg (approximately)

KEY PARAMETERS		
PARAMETER	VALUE	UNIT
$I_C$	0.1	A
$V_{CBO}$	30 - 80	V
$V_{CEO}$	30 - 65	V
$V_{EBO}$	5 - 6	V
$T_{J\ MAX}$	150	°C
Package	SOT-323	



SOT-323



ABSOLUTE MAXIMUM RATINGS ( $T_A = 25^\circ\text{C}$ unless otherwise noted)			
PARAMETER	SYMBOL	VALUE	UNIT
Power Dissipation	$P_D$	200	mW
Collector Current	$I_C$	0.1	A
Peak Collector Current	$I_{CM}$	0.2	A
Junction temperature range	$T_J$	-55 to +150	°C
Storage temperature range	$T_{STG}$	-55 to +150	°C

<b>ELECTRICAL SPECIFICATIONS</b> ( $T_A = 25^\circ\text{C}$ unless otherwise noted)						
<b>PARAMETER</b>		<b>CONDITIONS</b>	<b>SYMBOL</b>	<b>MIN</b>	<b>MAX</b>	<b>UNIT</b>
Collector-Base Breakdown Voltage	BC846AW/BW/CW	$I_C = 10\mu\text{A}$	$V_{CBO}$	80	-	V
	BC847AW/BW/CW			50	-	V
	BC848AW/BW/CW			30	-	V
	BC849AW/BW/CW			30	-	V
	BC850AW/BW/CW			50	-	V
Collector-Emitter Breakdown Voltage	BC846AW/BW/CW	$I_C = 10\text{mA}$	$V_{(BR)CEO}$	65	-	V
	BC847AW/BW/CW			45	-	V
	BC848AW/BW/CW			30	-	V
	BC849AW/BW/CW			30	-	V
	BC850AW/BW/CW			45	-	V
Emitter-Base Breakdown Voltage	BC846AW/BW/CW	$I_E = 1\mu\text{A}$	$V_{EBO}$	6	-	V
	BC847AW/BW/CW			6	-	V
	BC848AW/BW/CW			5	-	V
	BC849AW/BW/CW			5	-	V
	BC850AW/BW/CW			5	-	V
Collector Cut-off Current		$V_{CB} = 30\text{V}$	$I_{CBO}$	-	15	nA
Emitter Cut-off Current		$V_{EB} = 5\text{V}$	$I_{EBO}$	-	100	nA
DC Current Gain	BC846AW - BC850AW	$V_{CE} = 5\text{V}, I_C = 2\text{mA}$	$h_{FE}$	110	220	-
	BC846BW - BC850BW			200	450	-
	BC846CW - BC850CW			420	800	-
Collector-Emitter Saturation Voltage		$I_C = 10\text{mA}, I_B = 0.5\text{mA}$	$V_{CE(sat)}$	-	0.25	V
		$I_C = 100\text{mA}, I_B = 5\text{mA}$		-	0.60	V
Transition Frequency		$V_{CE} = 5\text{V}, I_C = 10\text{mA}, f = 100\text{MHz}$	$f_T$	100	-	MHz
Base Emitter Voltage		$V_{CE} = 5\text{V}, I_C = 2\text{mA}$	$V_{BE}$	0.58	0.70	V
		$V_{CE} = 5\text{V}, I_C = 10\text{mA}$		-	0.77	V
Collector Output Capacitance		$V_{CB} = 10\text{V}, I_E = 0, f = 1\text{MHz}$	$C_{ob}$	-	4.50	pF

<b>ORDERING AND MARKING INFORMATION</b>			
<b>ORDERING CODE</b>	<b>MARKING</b>	<b>PACKAGE</b>	<b>PACKING</b>
BC846AW RFG	1A	SOT-323	3K / 7" Reel
BC846BW RFG	1B	SOT-323	3K / 7" Reel
BC846CW RFG	1C	SOT-323	3K / 7" Reel
BC847AW RFG	1E	SOT-323	3K / 7" Reel
BC847BW RFG	1F	SOT-323	3K / 7" Reel
BC847CW RFG	1G	SOT-323	3K / 7" Reel
BC848AW RFG	1E	SOT-323	3K / 7" Reel
BC848BW RFG	1F	SOT-323	3K / 7" Reel
BC848CW RFG	1G	SOT-323	3K / 7" Reel
BC849AW RFG	1E	SOT-323	3K / 7" Reel
BC849BW RFG	1F	SOT-323	3K / 7" Reel
BC849CW RFG	1G	SOT-323	3K / 7" Reel
BC850AW RFG	1E	SOT-323	3K / 7" Reel
BC850BW RFG	1F	SOT-323	3K / 7" Reel
BC850CW RFG	1G	SOT-323	3K / 7" Reel
BC846AW RF	1A	SOT-323	3K / 7" Reel
BC846BW RF	1B	SOT-323	3K / 7" Reel
BC846CW RF	1C	SOT-323	3K / 7" Reel
BC847AW RF	1E	SOT-323	3K / 7" Reel
BC847BW RF	1F	SOT-323	3K / 7" Reel
BC847CW RF	1G	SOT-323	3K / 7" Reel
BC848AW RF	1E	SOT-323	3K / 7" Reel
BC848BW RF	1F	SOT-323	3K / 7" Reel
BC848CW RF	1G	SOT-323	3K / 7" Reel
BC849AW RF	1E	SOT-323	3K / 7" Reel
BC849BW RF	1F	SOT-323	3K / 7" Reel
BC849CW RF	1G	SOT-323	3K / 7" Reel
BC850AW RF	1E	SOT-323	3K / 7" Reel
BC850BW RF	1F	SOT-323	3K / 7" Reel
BC850CW RF	1G	SOT-323	3K / 7" Reel

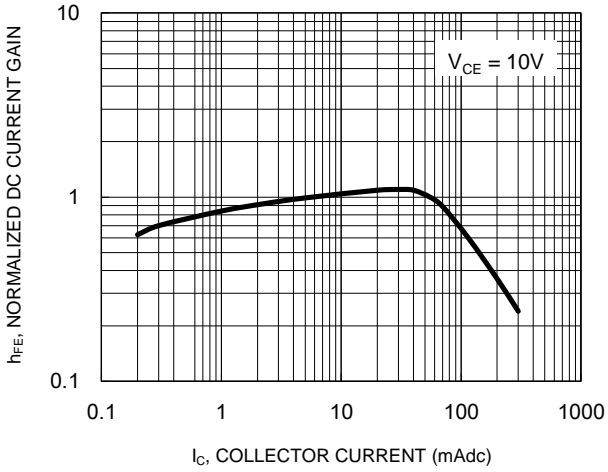
**Notes:**

1. "G" means green compound (halogen free)

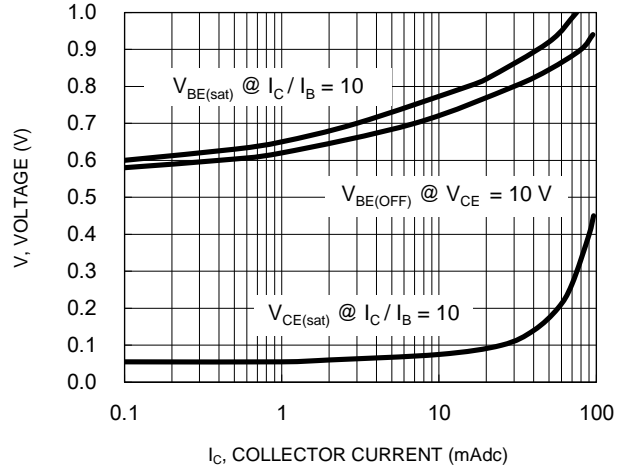
**CHARACTERISTICS CURVES**

( $T_A = 25^\circ\text{C}$  unless otherwise noted)

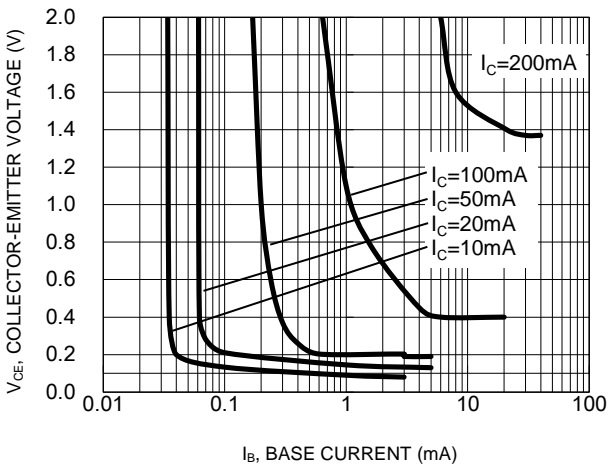
**Fig.1 Normalized DC Current Gain**



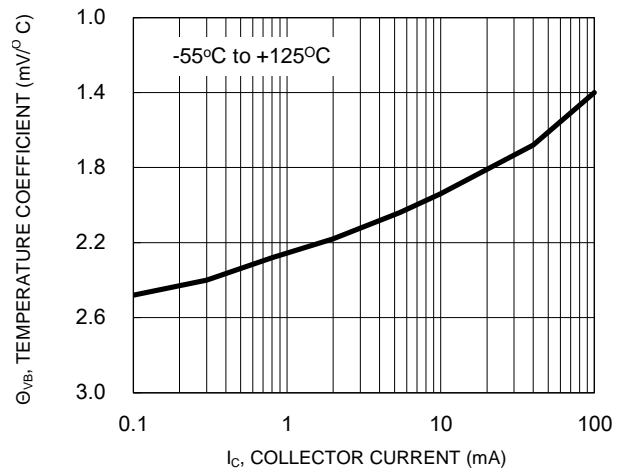
**Fig.2 "Saturation" and "On" Voltages**



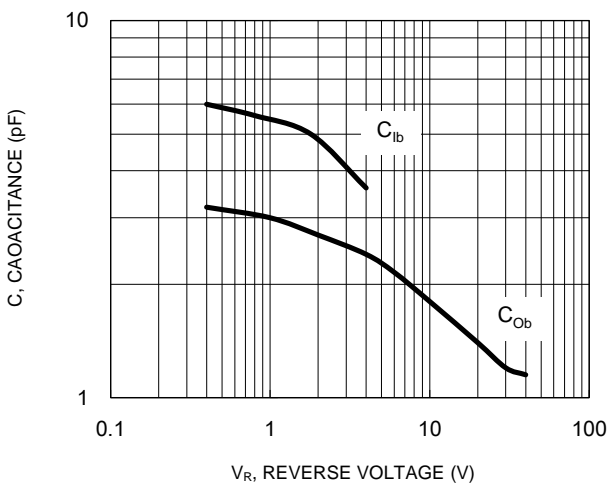
**Fig.3 Collector Saturation Region**



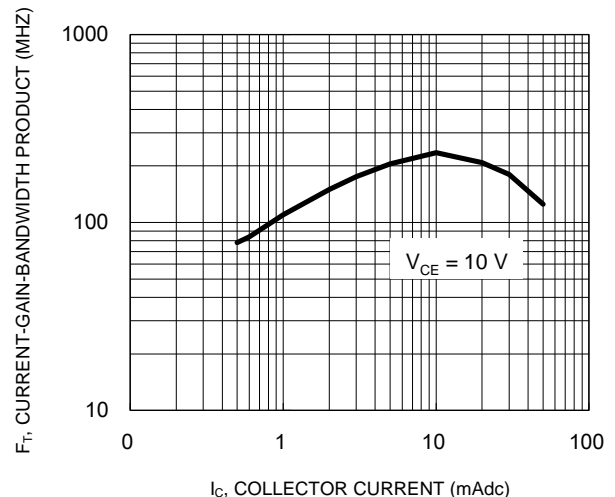
**Fig.4 Base-Emitter Current (mA)**



**Fig.5 Capacitances**



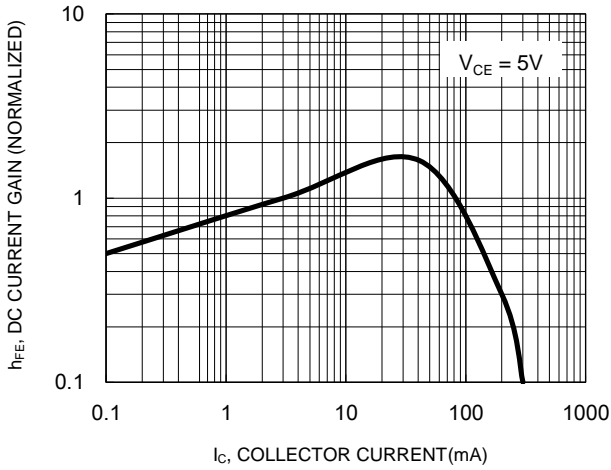
**Fig.6 Current-Gain-Bandwidth Product**



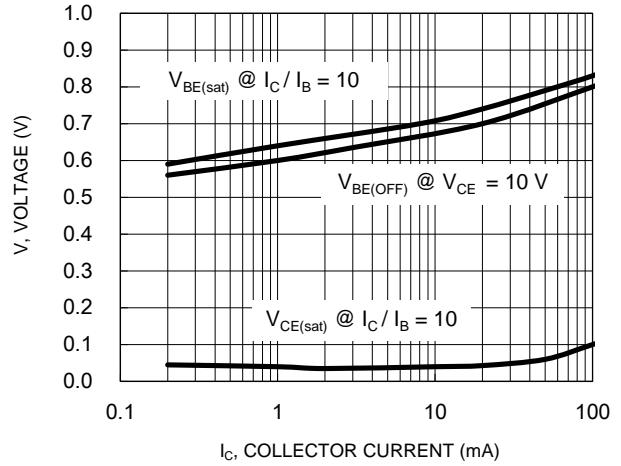
**CHARACTERISTICS CURVES**

( $T_A = 25^\circ\text{C}$  unless otherwise noted)

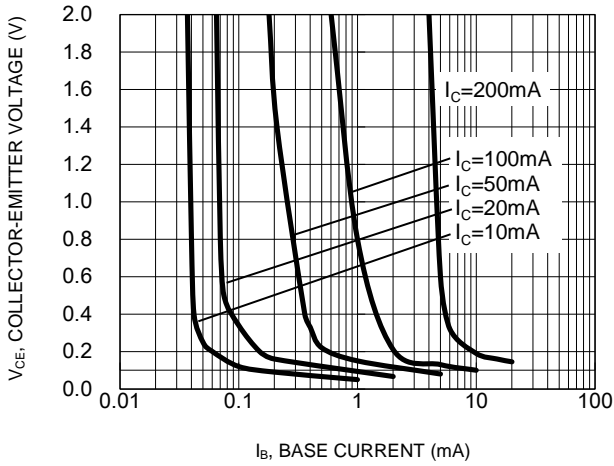
**Fig.7 DC Collector Current (mA)**



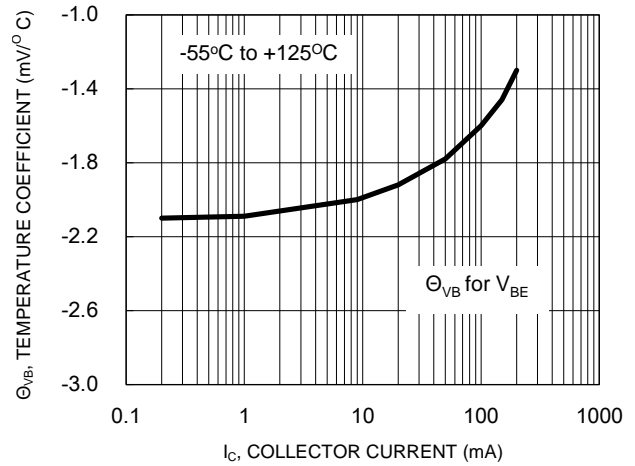
**Fig.8 "On" Voltage**



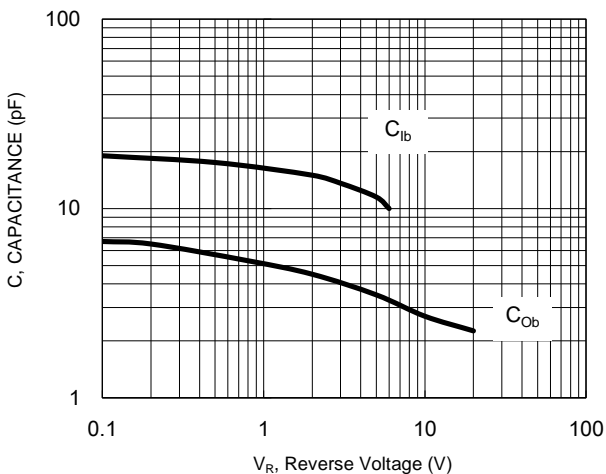
**Fig.9 Collector Saturation Region**



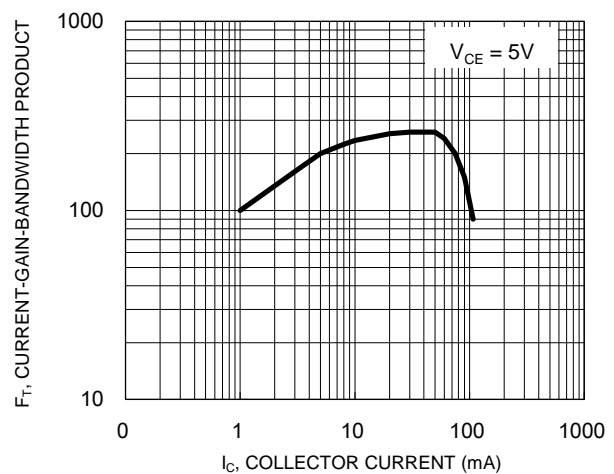
**Fig.10 Base-Emitter Temperature Coefficient**



**Fig.11 Capacitance**

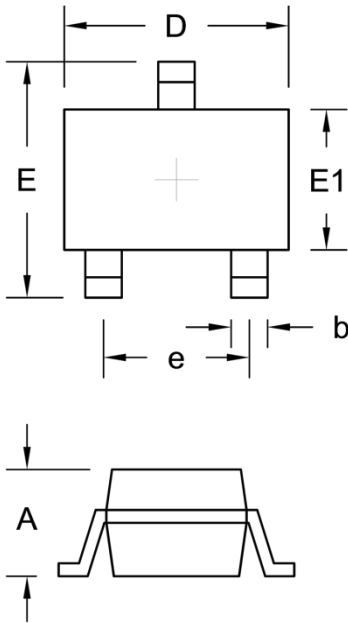


**Fig.12 Current-Gain-Bandwidth Product**



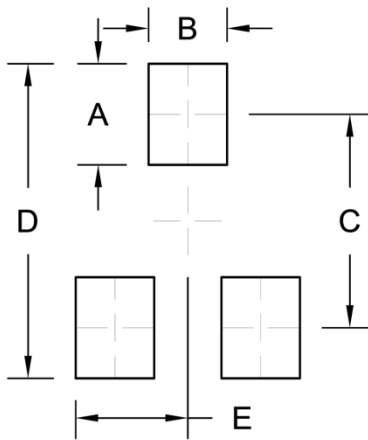
**PACKAGE OUTLINE DIMENSIONS**

SOT-323



DIM.	Unit (mm)		Unit (inch)	
	Min.	Max.	Min.	Max.
A	0.80	1.10	0.031	0.043
b	0.25	0.40	0.010	0.016
D	1.80	2.20	0.071	0.087
E	1.80	2.40	0.071	0.094
E1	1.15	1.35	0.045	0.053
e	1.30 (TYP)		0.051 (TYP)	

**SUGGESTED PAD LAYOUT**



Symbol	Unit (mm)	Unit (inch)
A	0.90	0.035
B	0.70	0.028
C	1.90	0.075
D	2.80	0.110
E	1.00	0.039